

Engine Control

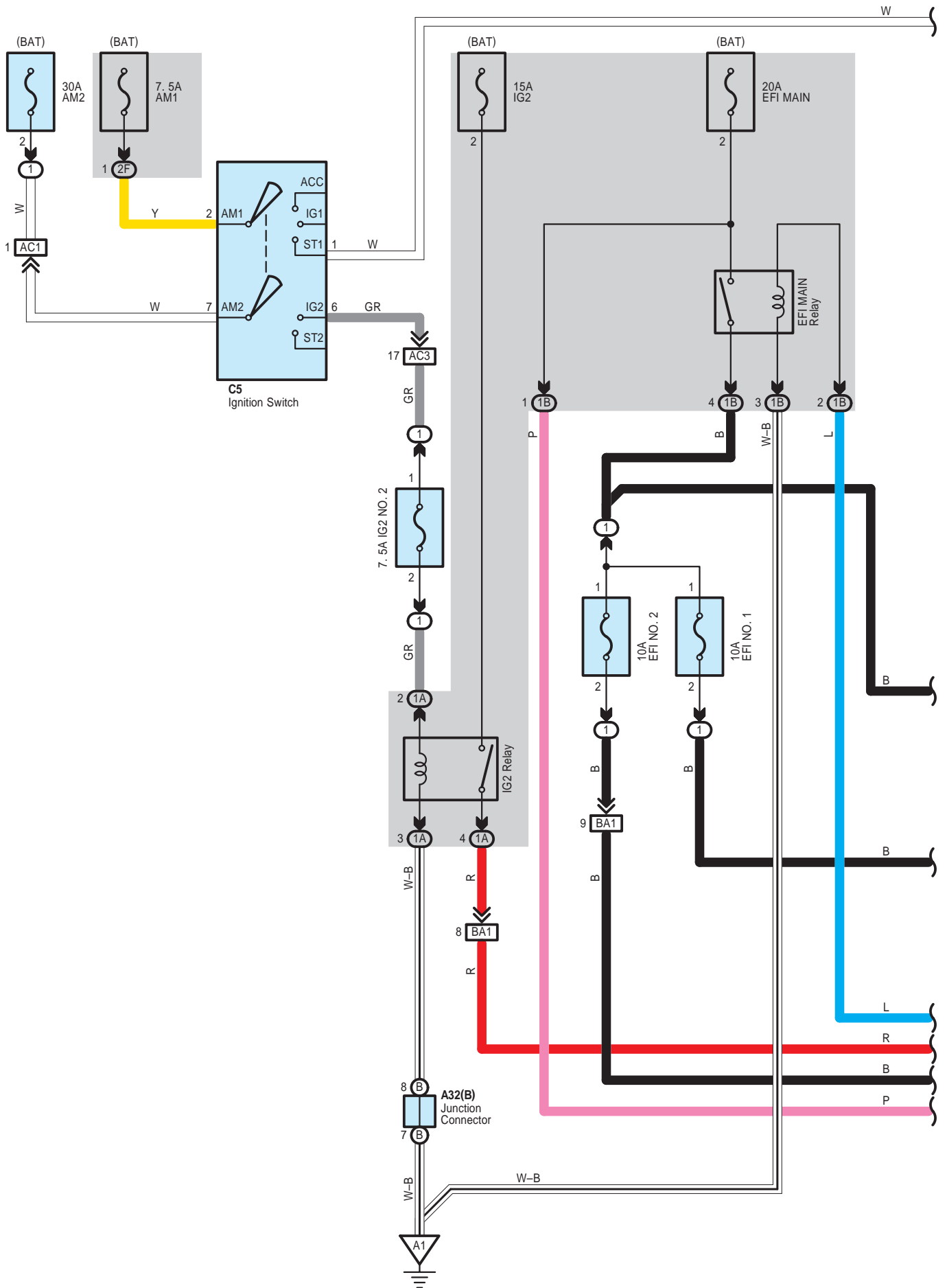

Engine Control

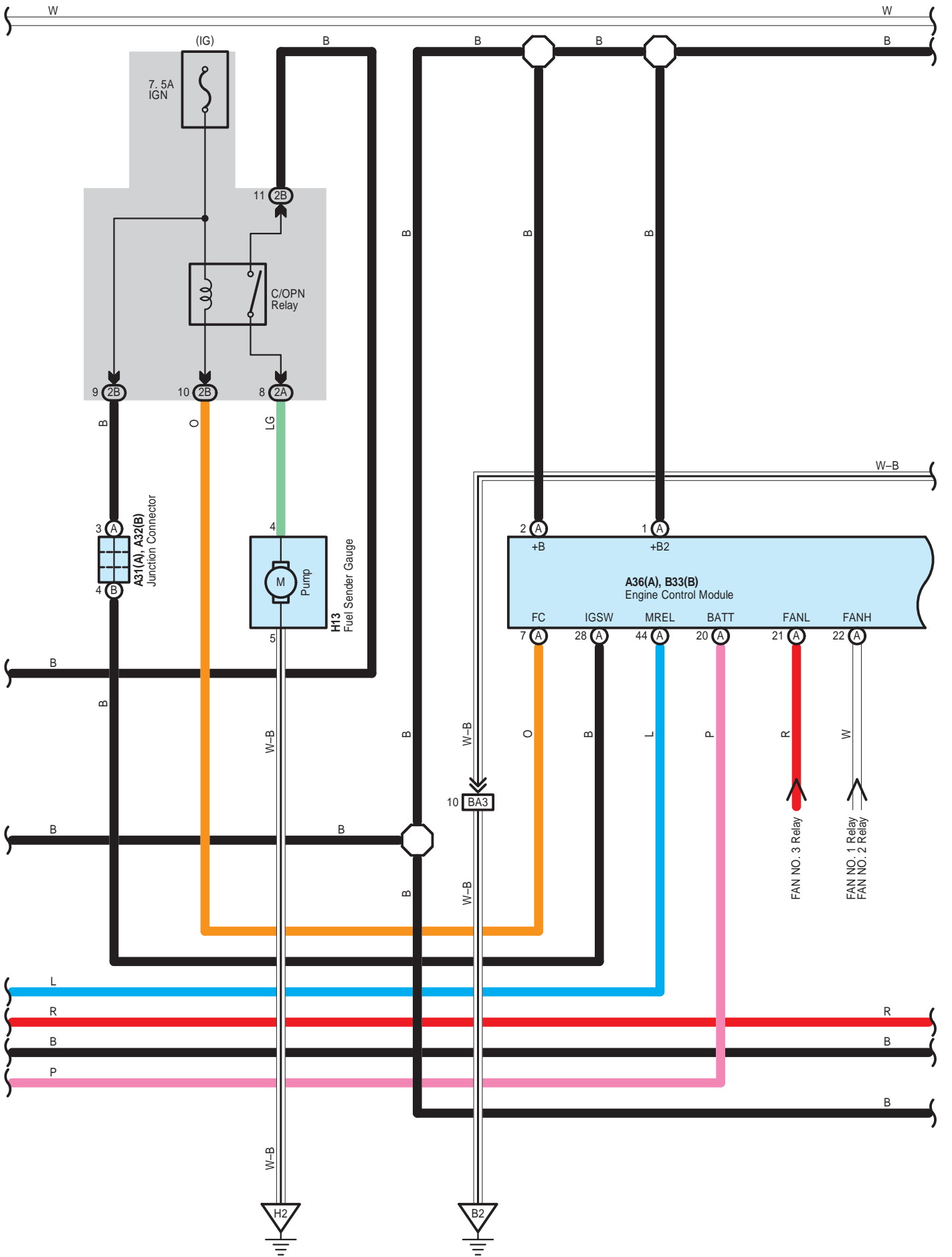

Engine Control

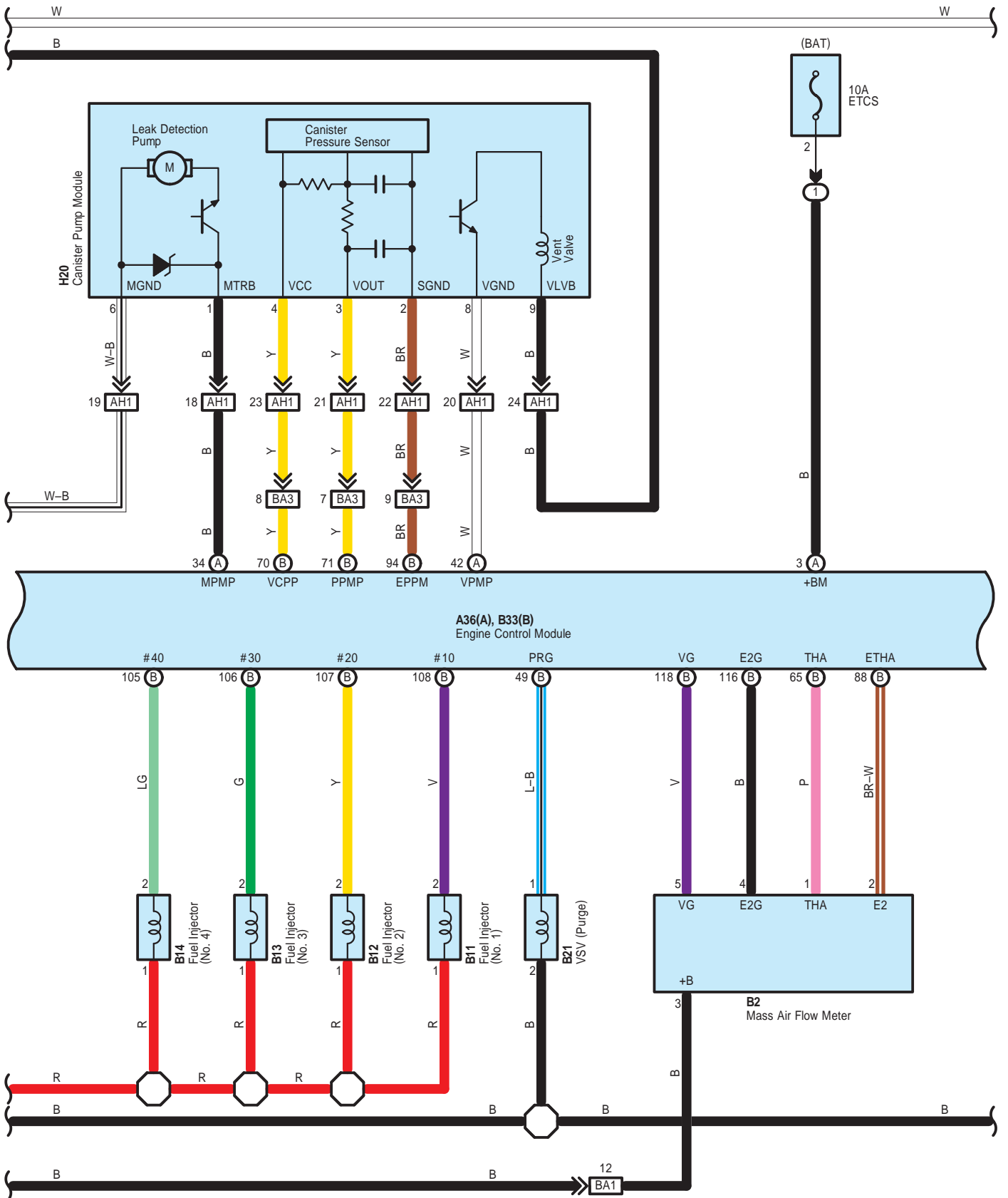

Engine Control

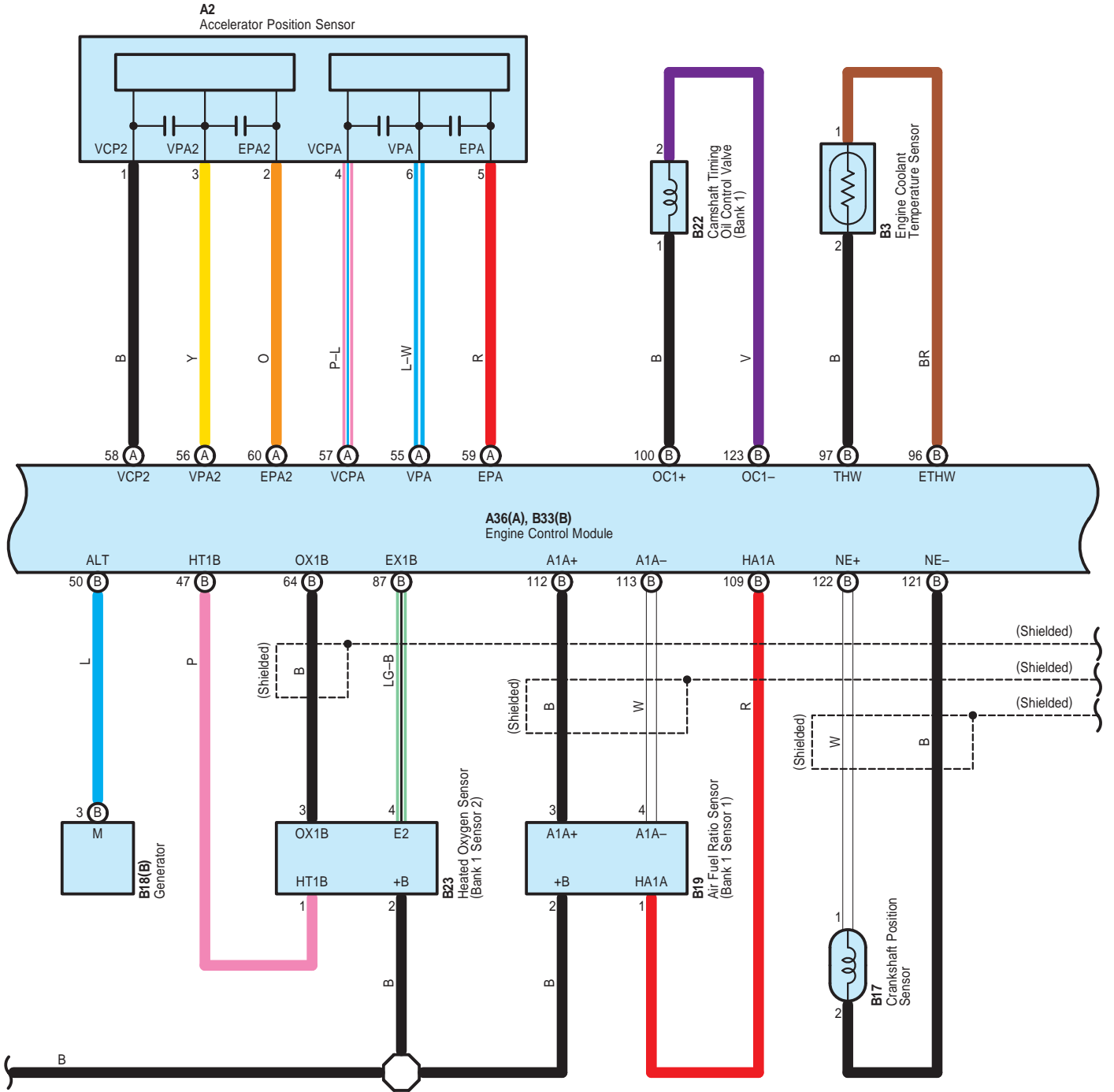

Engine Control

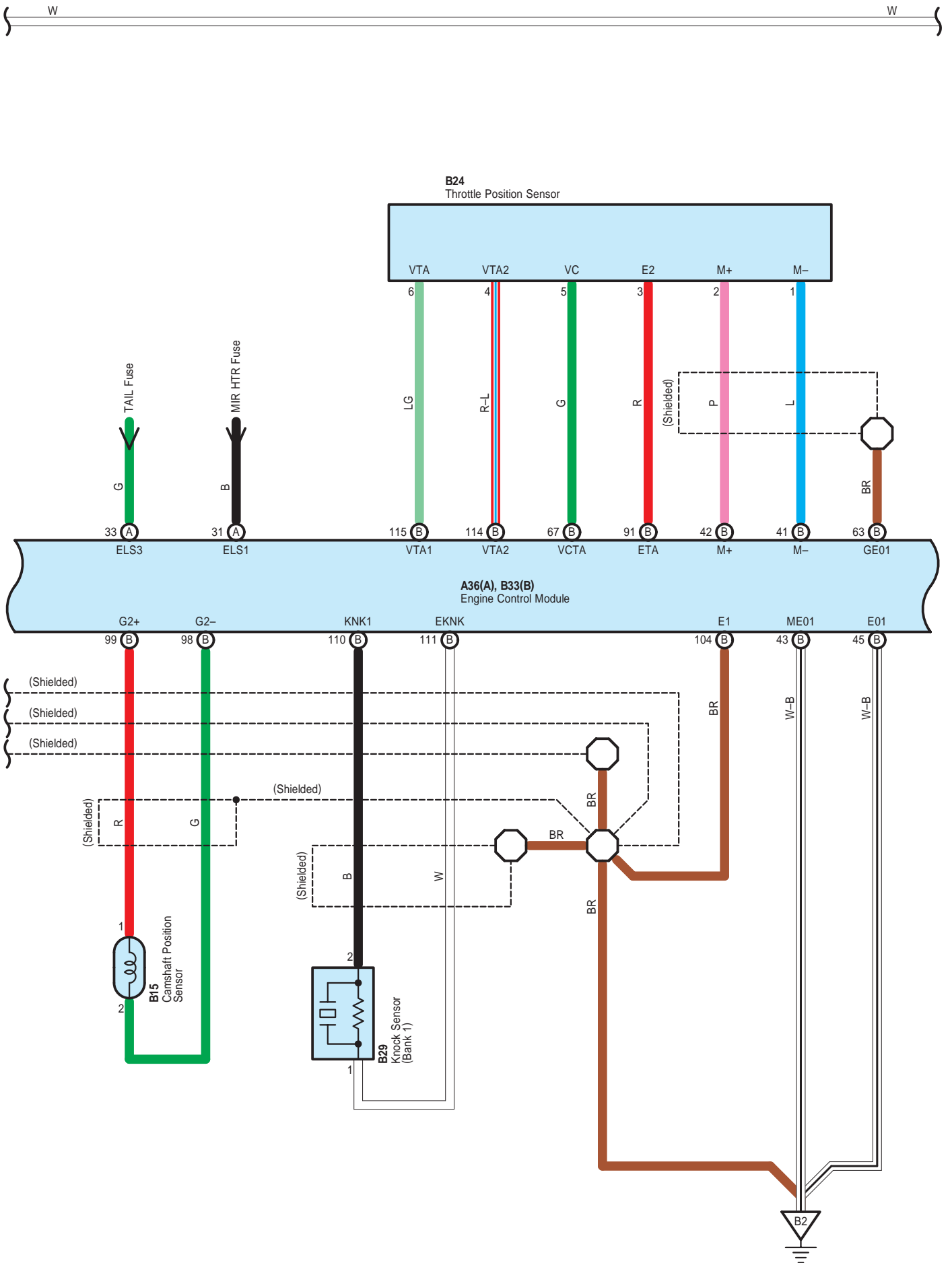

Engine Control

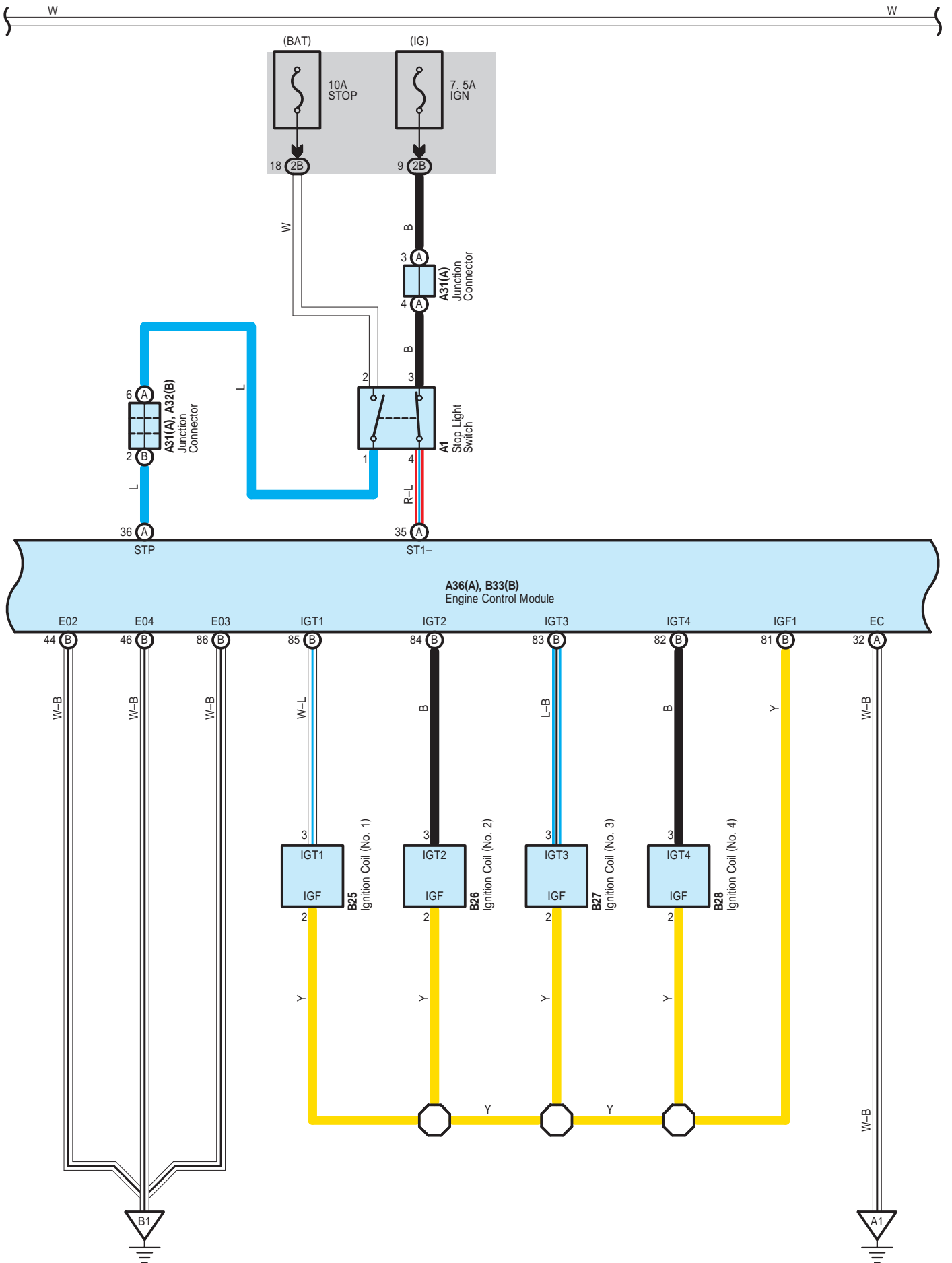

Engine Control

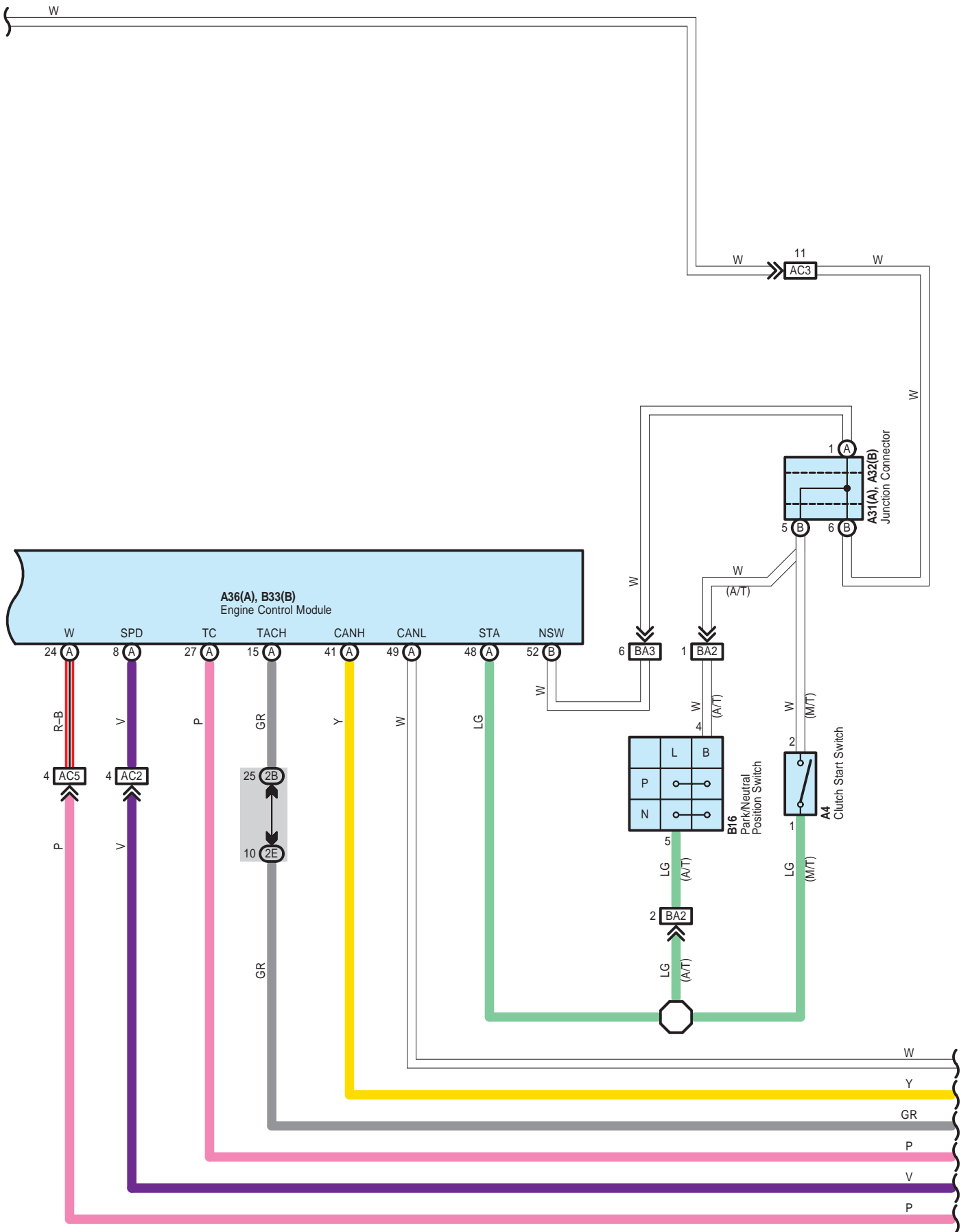

Engine Control

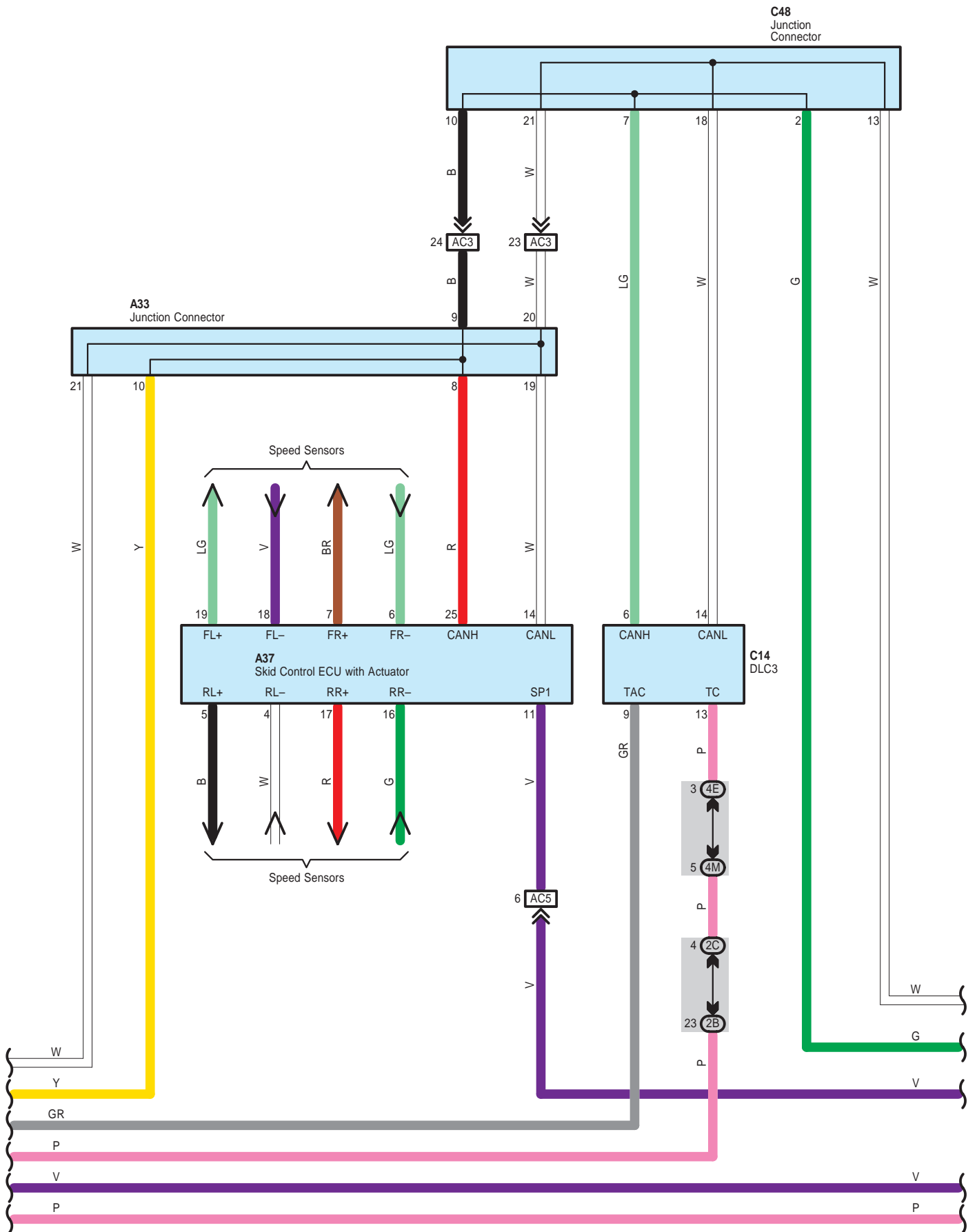

Engine Control

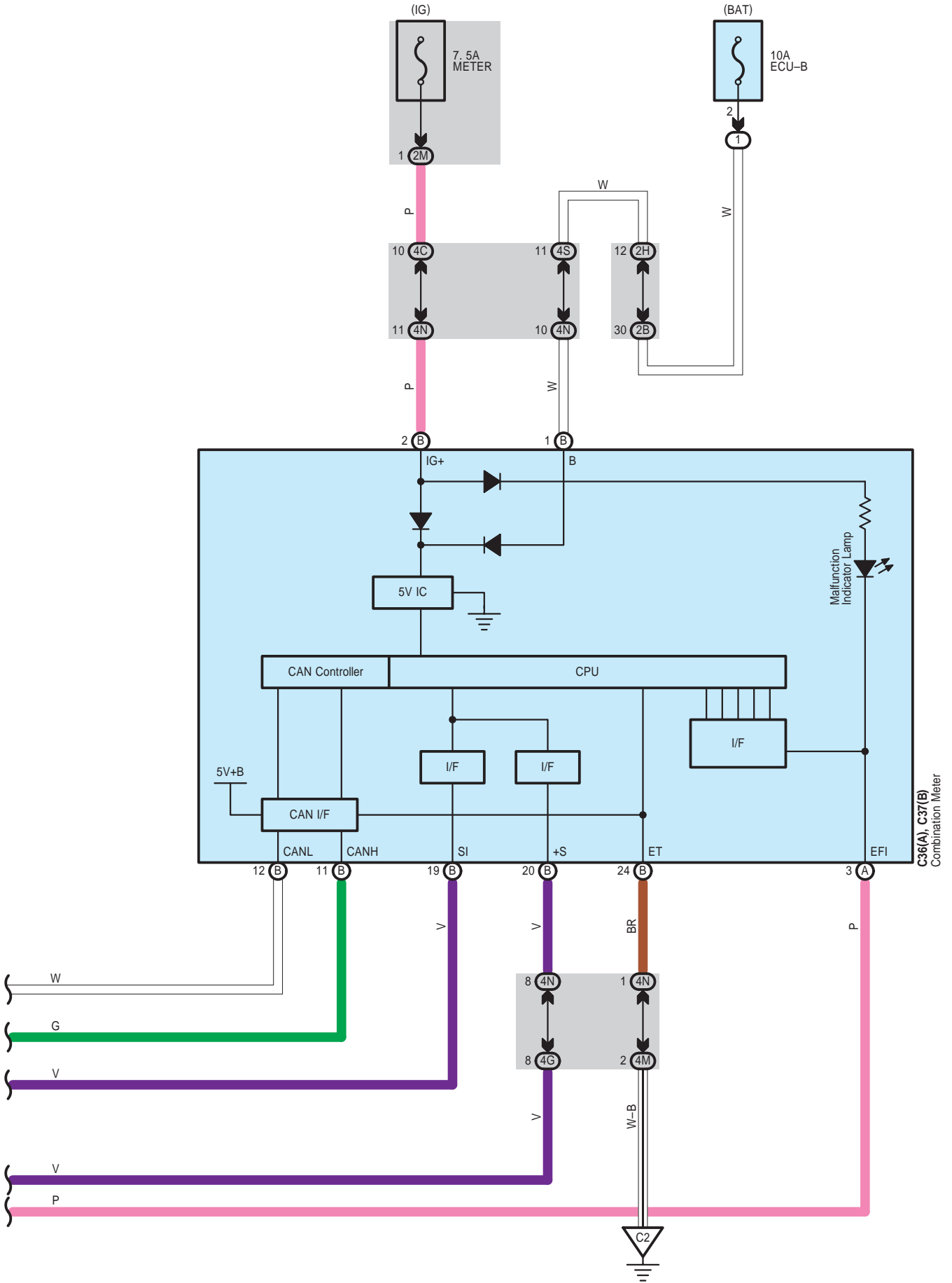

Engine Control

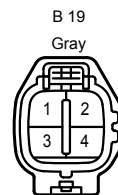
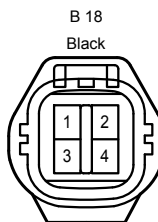
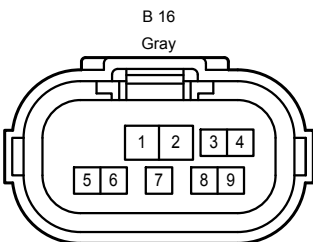
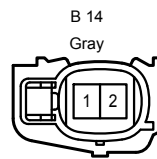
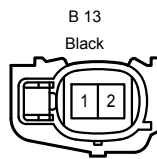
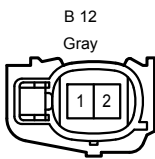
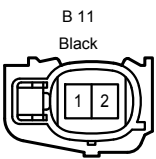
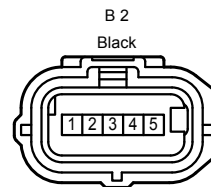
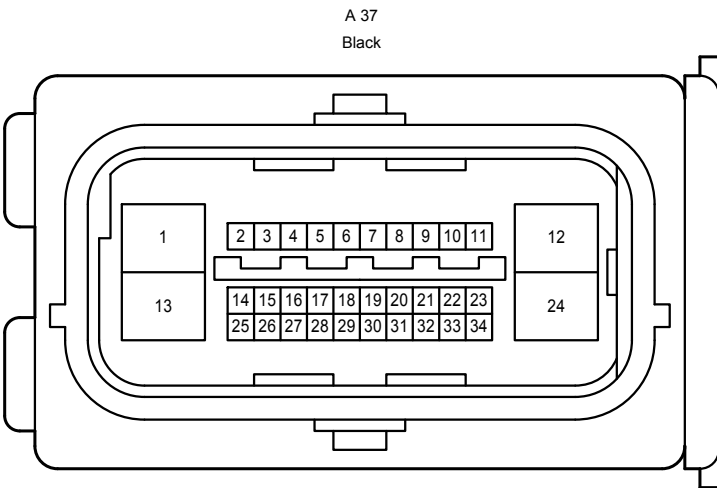
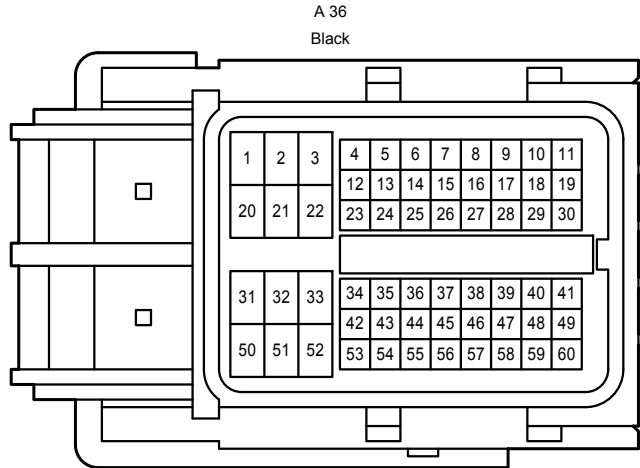
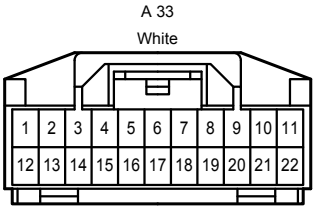
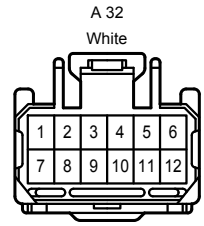
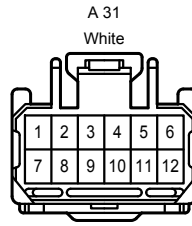
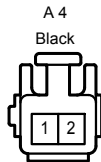
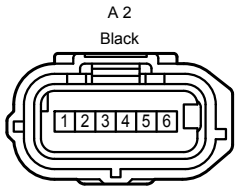
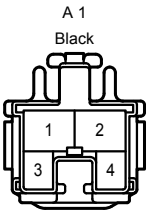

Engine Control

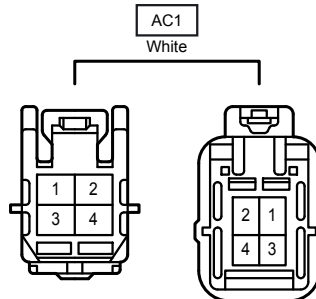
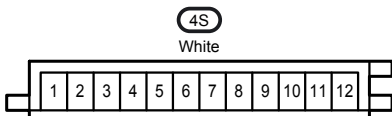
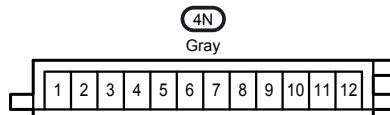
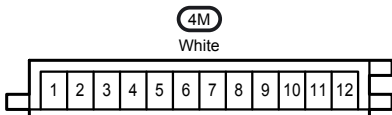
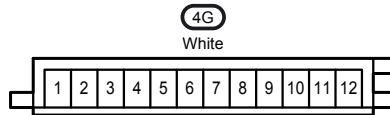
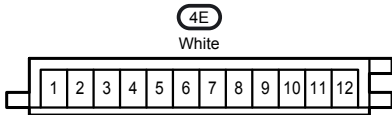
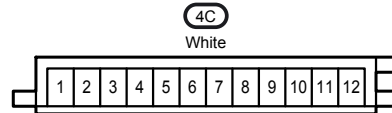
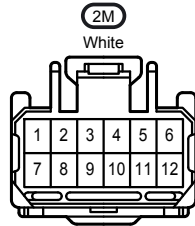
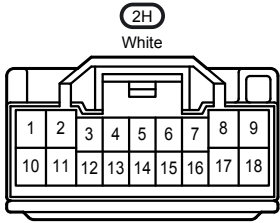
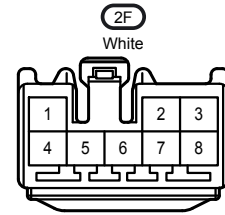
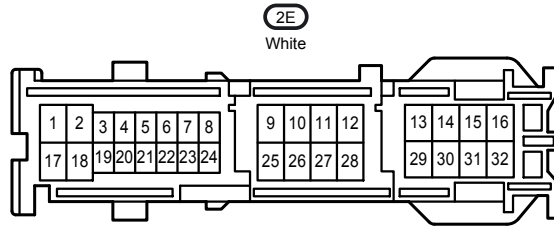
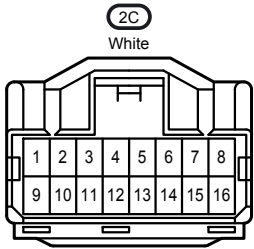
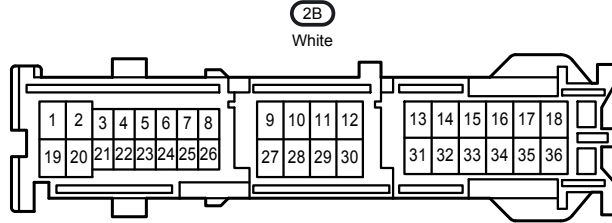
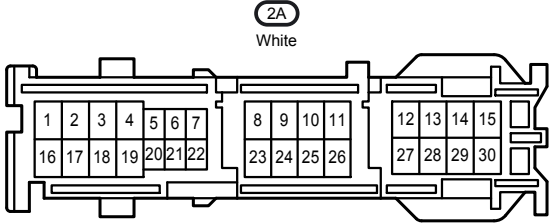
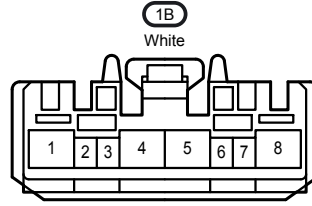
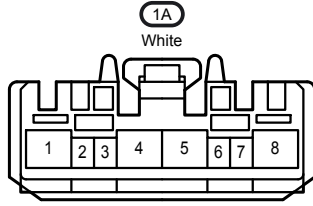
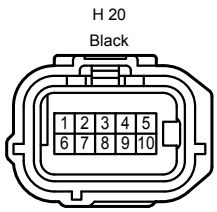

AC2
Gray

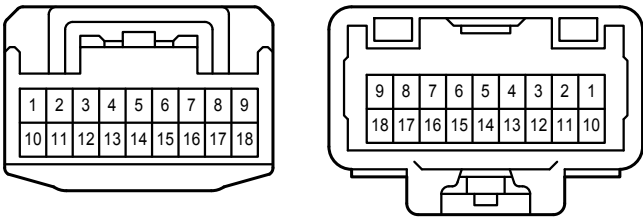

AC3
White

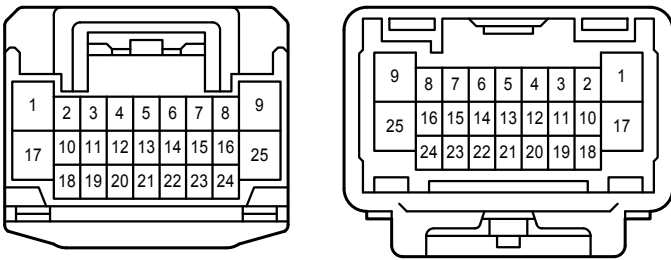

AC5
White

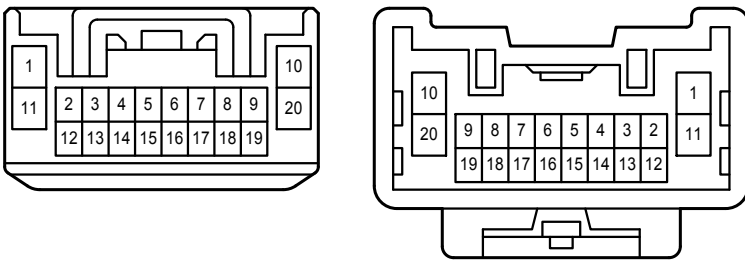

AH1
White

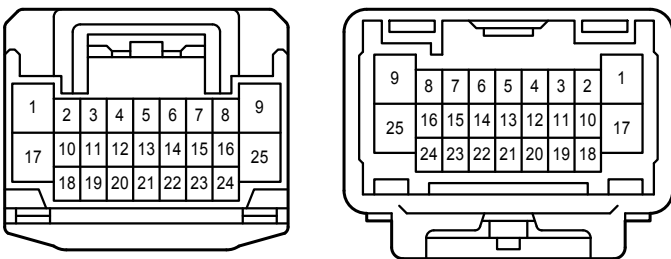

BA1
White

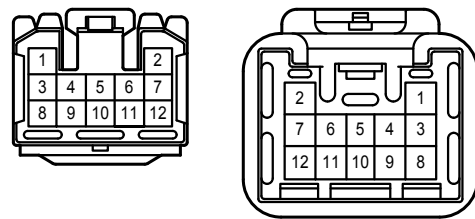

BA2
Gray

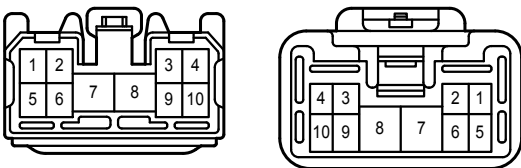

BA3
Gray

