

Combination Meter

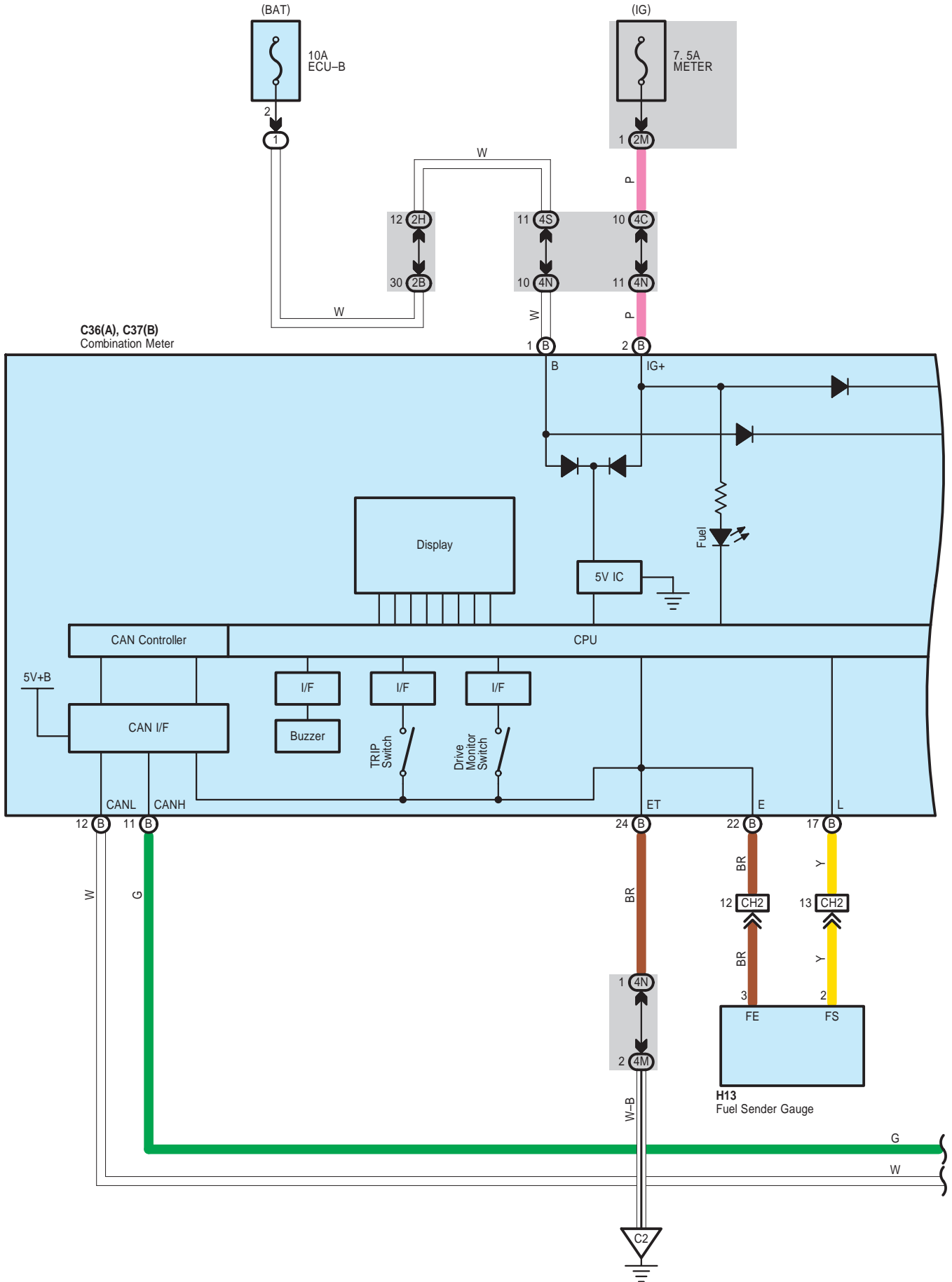

Combination Meter

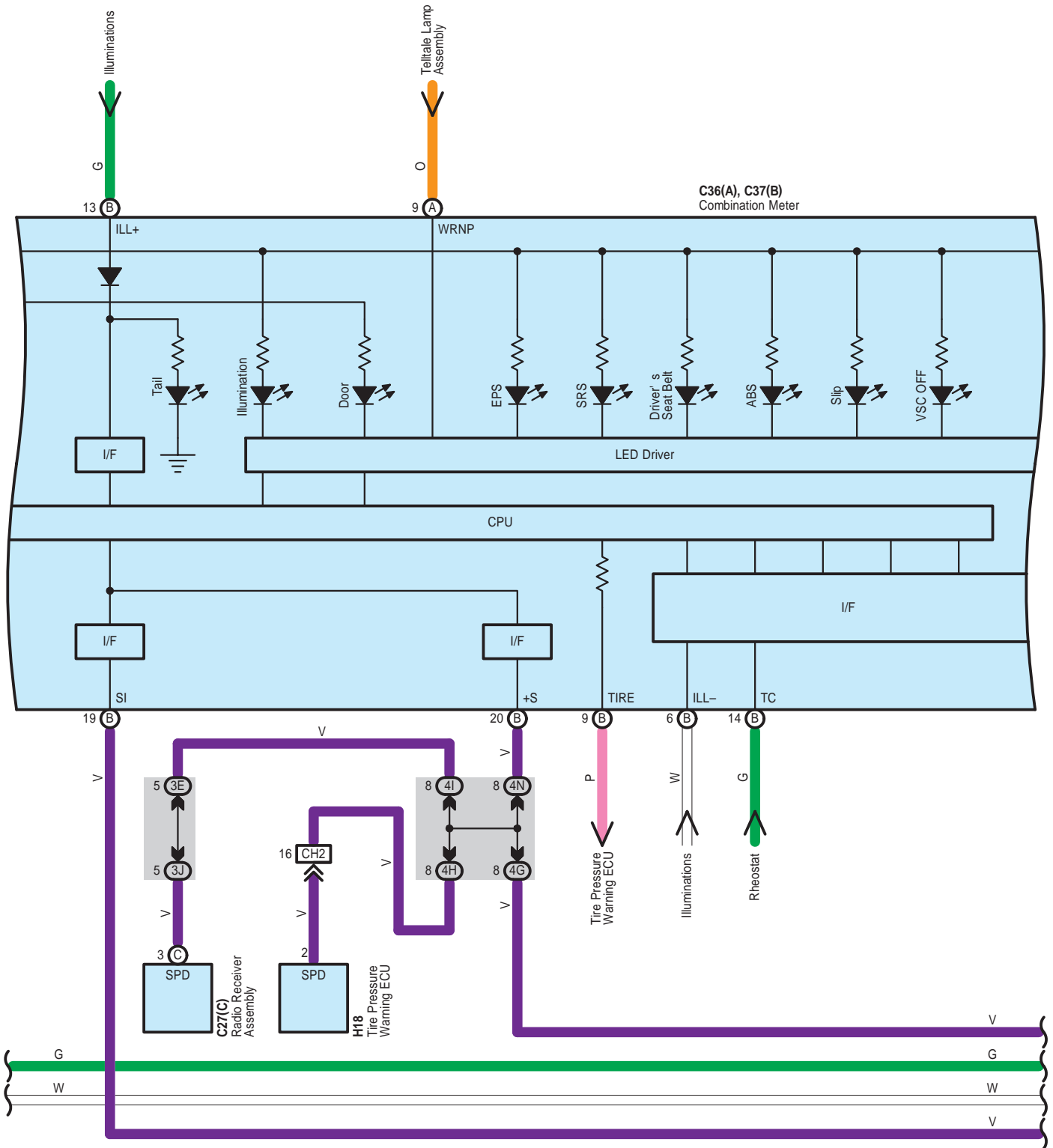

C36(A), C37(B)
Combination Meter

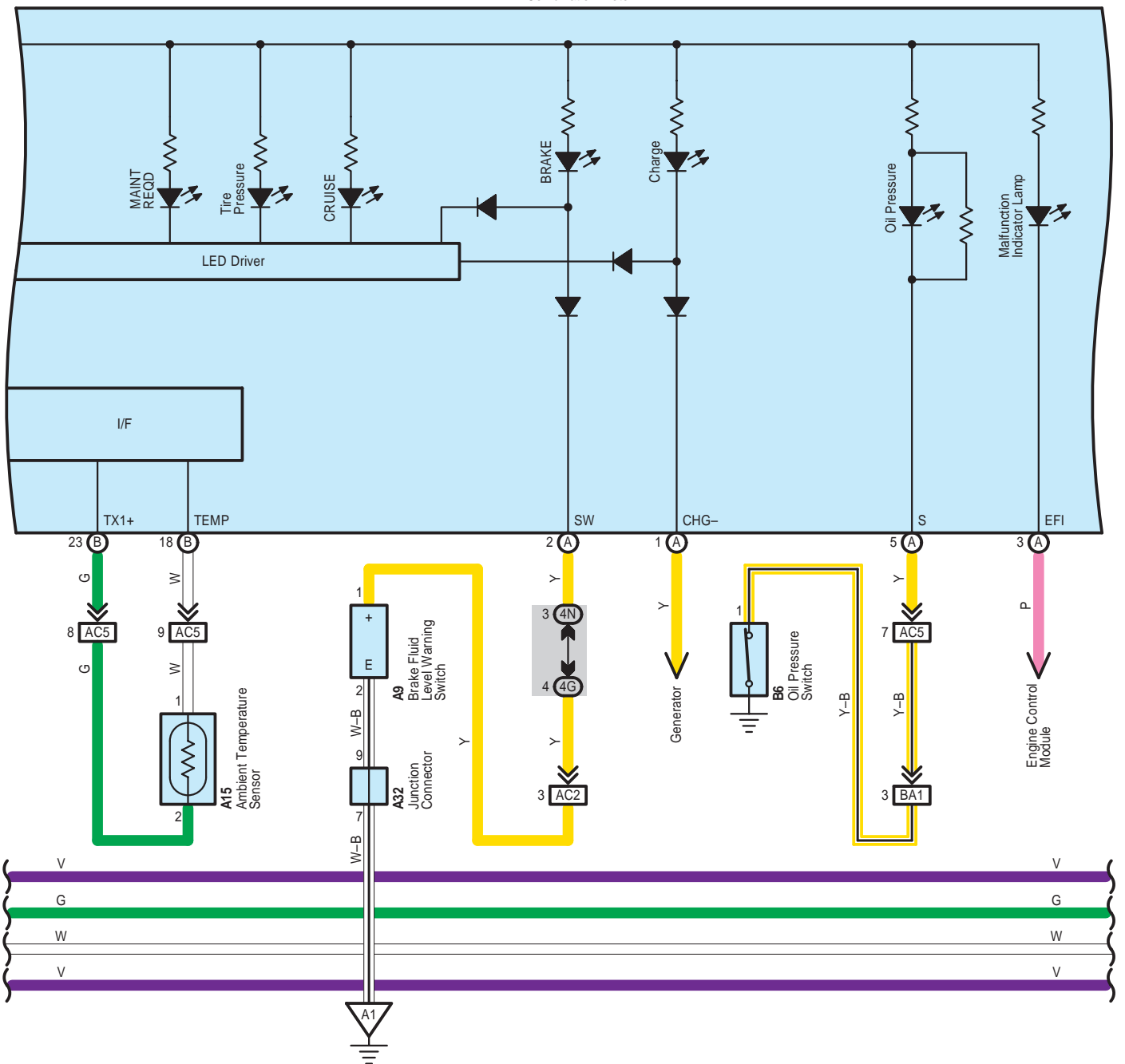

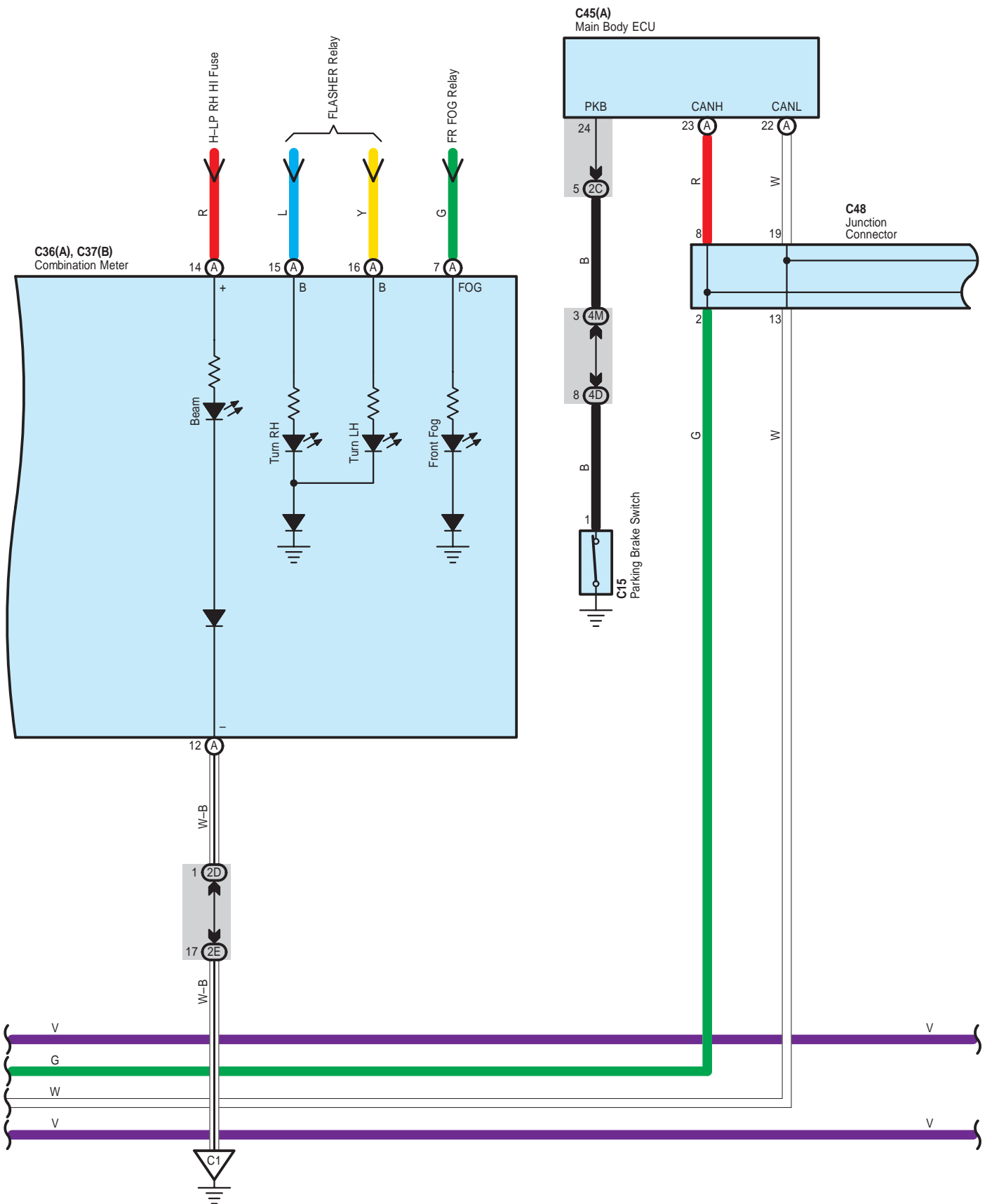

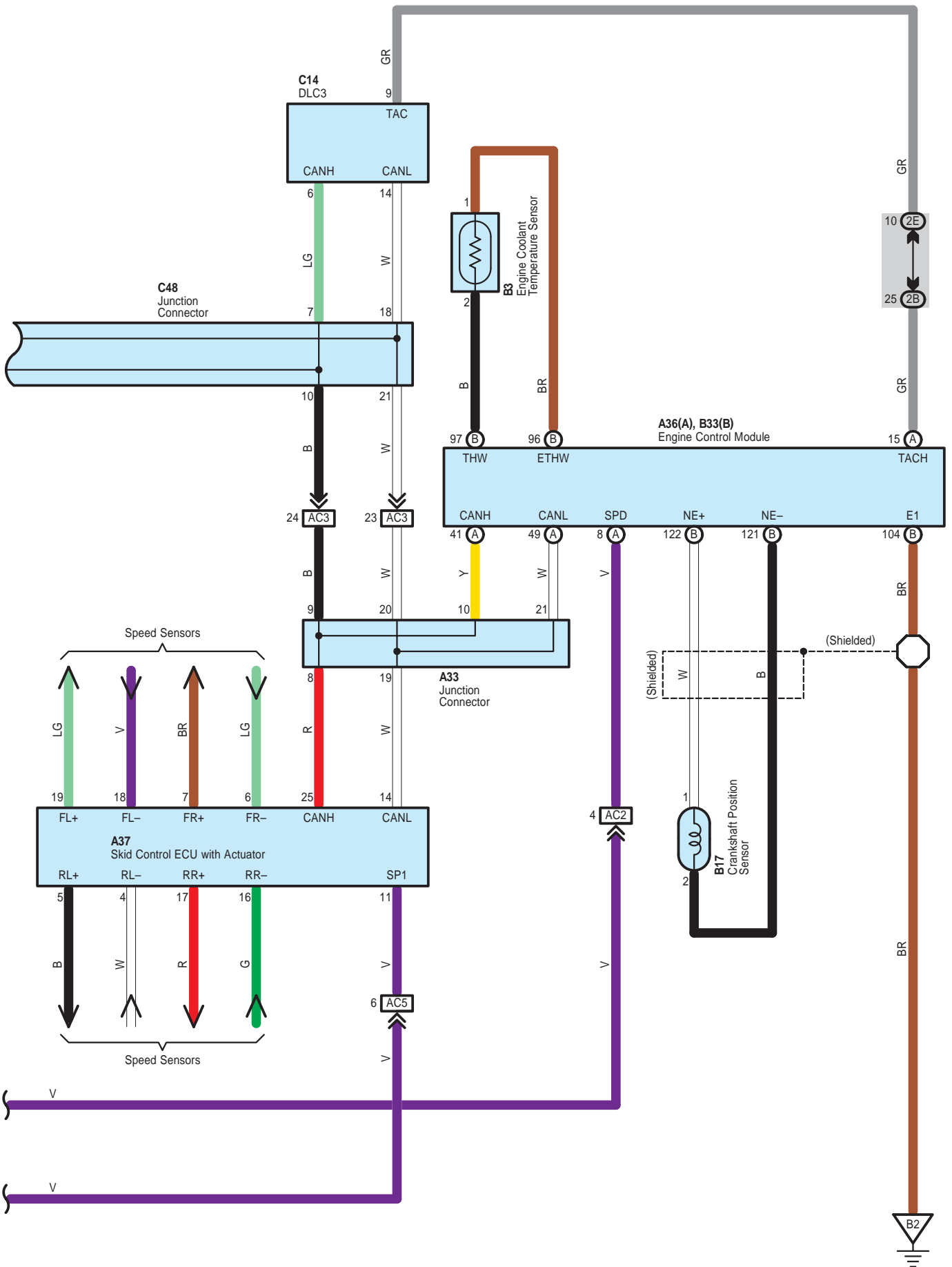

Combination Meter

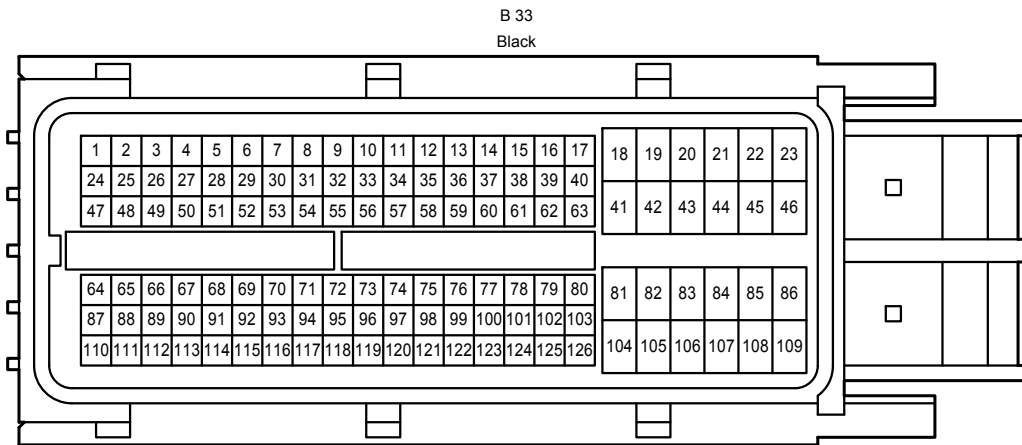
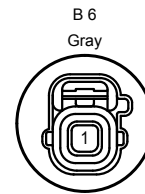
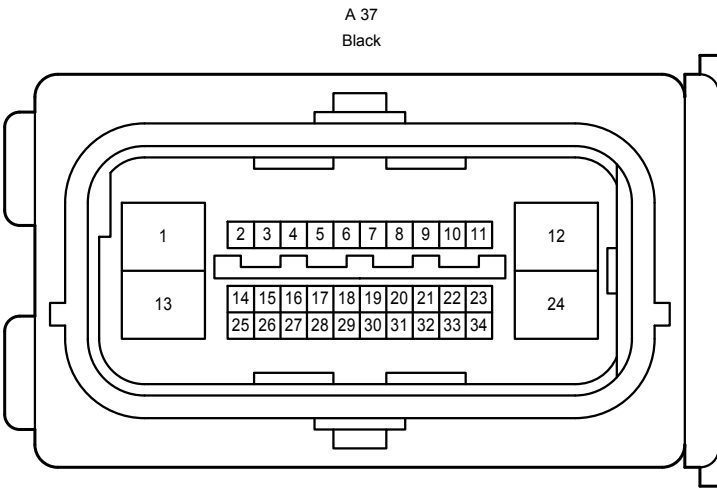
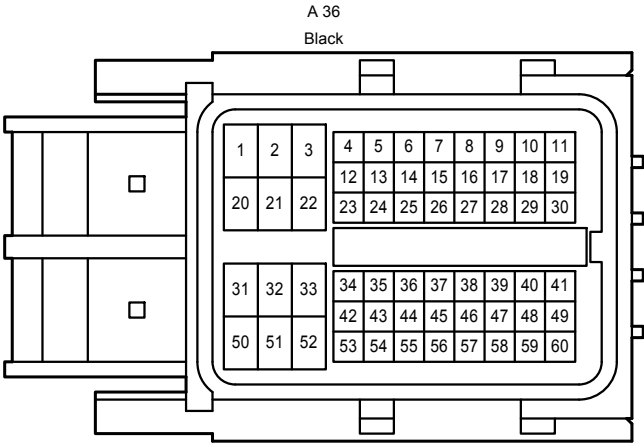
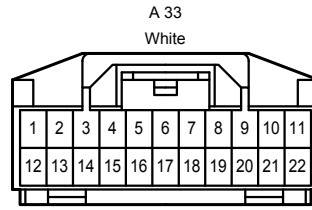
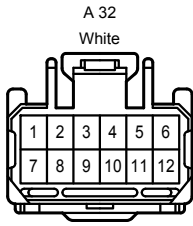

Combination Meter

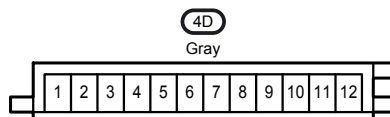
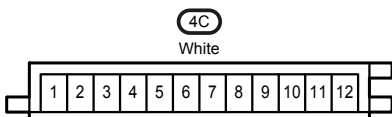
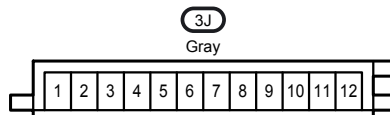
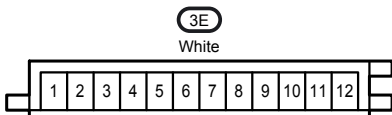
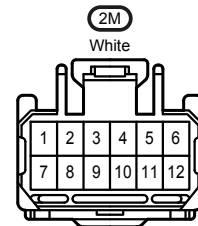
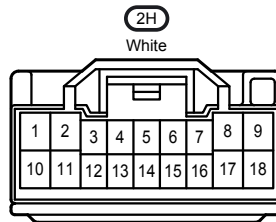
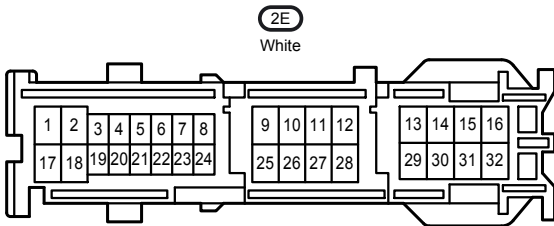
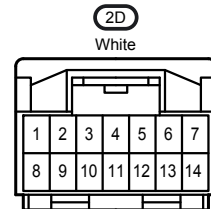
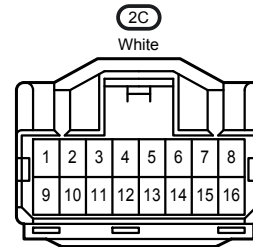
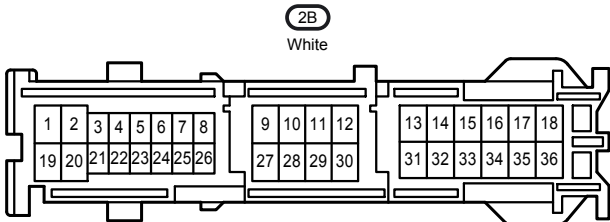
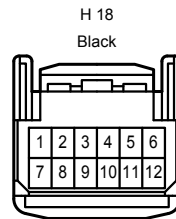
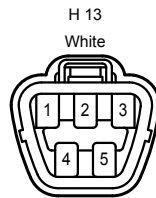
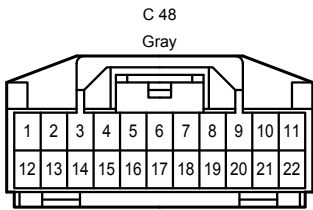
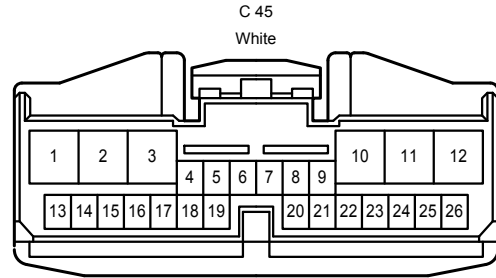
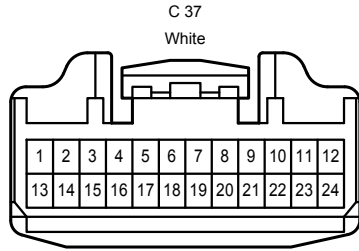
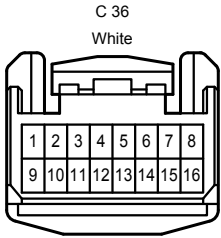
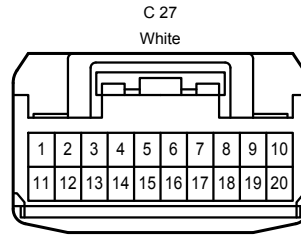
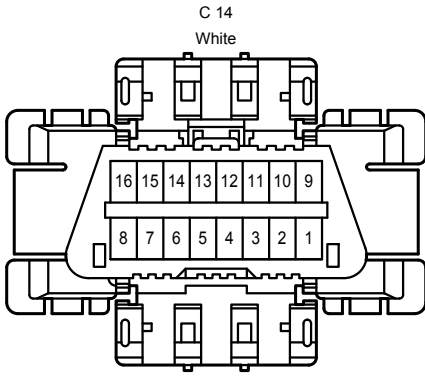

Combination Meter

4G

White

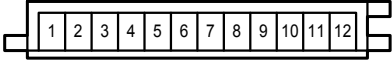

4H

Gray

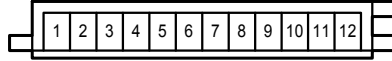

4I

White

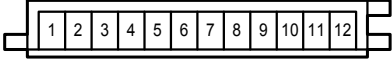

4M

White

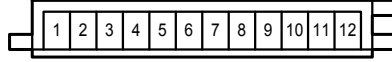

4N

Gray

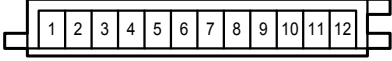

4S

White

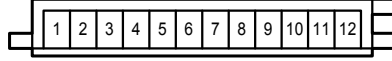

AC2

Gray

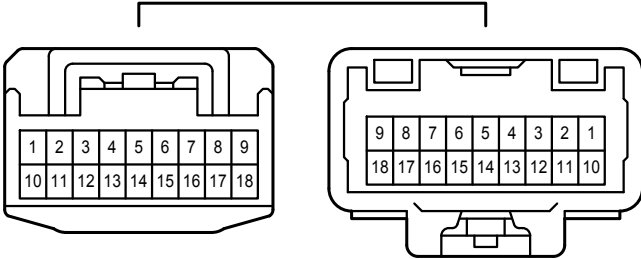

AC3

White

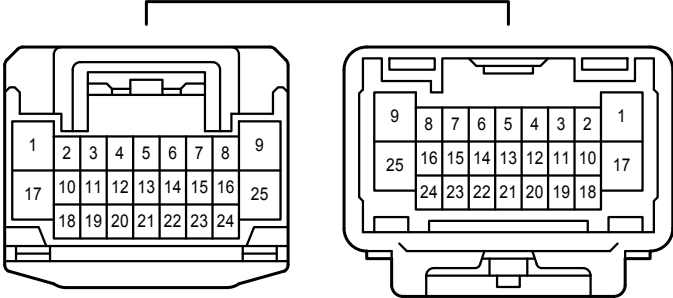

AC5

White

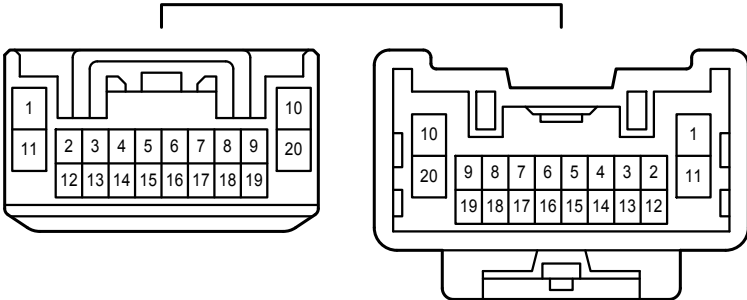

BA1
White

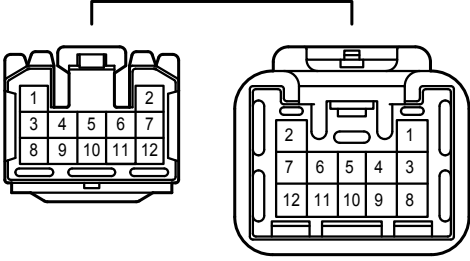

CH2
White

